

# Manual Proton FXQ



## Table of Contents

DESCRIPTION .....	2
PACKAGE CONTENTS .....	3
SPECIFICATIONS .....	3
FEATURES .....	4
COMPONENTS AND CONTROLS .....	6
BUTTON OPERATION.....	7
USING THE BATTERY PACK .....	8
BATTERY CHARGING.....	8
BATTERY INSTALLATION .....	12
PRECAUTIONS.....	12
RECOMMENDATIONS FOR USE .....	13
EXTERNAL POWER SUPPLY.....	13
OPERATION .....	14
MOUNTING ATTACHMENT ON OPTICAL RIFLESCOPE.....	14
POWERING ON AND IMAGE SETTING .....	16
MICROBOLOMETER CALIBRATION .....	17
IMAGE DETAIL BOOST .....	17
STATUS BAR.....	18
QUICK MENU FUNCTIONS.....	19
MAIN MENU FUNCTIONS .....	19
ENTER THE MAIN MENU .....	19
MODE .....	20
IMAGE DETAIL BOOST .....	21
WI-FI SETTINGS.....	21

GENERAL SETTINGS .....	22
COLOR MODES .....	25
DEVICE INFORMATION .....	26
DEFECTIVE PIXEL REPAIR .....	27
MICROPHONE.....	28
ICON BRIGHTNESS .....	<b>Feil! Bokmerke er ikke definert.</b>
CALIBRATION MODE .....	29
VIDEO RECORDING AND PHOTOGRAPHY.....	29
WI-FI FUNCTION .....	31
DISPLAY OFF FUNCTION .....	31
DISPLAY CALIBRATION.....	32
STREAM VISION .....	34
FIRMWARE UPDATE .....	34
USB CONNECTION .....	35
TECHNICAL INSPECTION .....	36
TECHNICAL MAINTENANCE AND STORAGE .....	37
TROUBLESHOOTING .....	37
The device does not turn on .....	37
The device does not operate from an external power source.....	37
Blurred image with vertical stripes or an uneven background .....	37
Poor quality image. There is noise or ghost images of previous scenes or objects.....	38
Image is too dark.....	38
Color bars appear on the display or the image disappears .....	38
The image of the object being observed is missing .....	38
Missing or interrupted broadcasting via Wi-Fi.....	39
When the device is used in low temperature conditions the image quality is worse than in positive temperatures. ....	40
LEGAL COMPLIANCES AND DISCLAIMERS .....	41

## DESCRIPTION

Thermal Imaging Front Attachment **Proton FXQ30** is a multipurpose device that allows you to quickly and easily transform a daylight riflescope into a thermal imaging one.

The attachment is mounted on the lens of an riflescope with the help of adapters designed for various lens diameters. The attachment does not require any additional adjustment.

The attachment is intended for various applications, including hunting, sport shooting, night photography & video recording, and surveillance.

## PACKAGE CONTENTS

- Proton FXQ30 Thermal Imaging Attachment
- Carrying Case
- 2x APS 5 Rechargeable Battery
- 2x Lock-cover for APS 5 Battery
- Battery Pack Charger
- Power Adapter
- USB Type-C Cable
- Quick Start Guide
- Lens-Cleaning Cloth
- Warranty Card

## SPECIFICATIONS

<b>Model</b>	<b>FXQ30</b>
SKU	76653
<b>Microbolometer</b>	
Type	Uncooled
Resolution, Pixels	384x288
Pixel Pitch, $\mu\text{m}$	17
Frame Rate, Hz	50
<b>Optical Characteristics</b>	
Magnification of attachment, x	1
Recommended daylight optics magnification, x	1.5-4
Lens	F30/1.2
Field-of-view (Horizontal), deg/m per 100 m	12.4 / 21.8
Detection Range (animal height 1.7 m), m/y	900 / 984.25
Minimum Observation Distance, m/y	15 / 16.4
<b>Display</b>	
Type	AMOLED
Resolution, Pixels	1024x768
<b>Operational Characteristics</b>	
Power Supply, V	3-4.2

Battery type/ Capacity/ Rated Output Voltage	Li-Ion Battery Pack APS 5 / 4900 mAh / DC 3.7 V
External Power Supply	5 V (USB Type-C)
Max. Battery Pack Life (at t = 22 °C), Hour*	6
Maximum Recoil Power When Used with a Rifled Weapon, Joules	6000
Maximum Shock-Resistance When Used with a Slug Gun, Caliber	12
Degree of protection IP code (IEC60529)	IPX7
Operating temperature, °C	-25 ... +50
Overall Dimensions, mm/inch	119x58x75 / 4.69x2.28x2.95
Weight (without Battery), kg/oz	0.3 / 10.58
<b>Video Recorder</b>	
Photo/Video Resolution, Pixels	864x648
Video/Photo Format	.mp4 / .jpg
Built-in Memory	16 GB
About 8 hours of video or more than 100 000 photos	About 5 hours of video or more than 100 000 photos
<b>Wi-Fi Channel**</b>	
Frequency	2.4 GHz
Standard	802.11 b/g

\* Actual operating time will depend to what extent the Wi-Fi and built-in video recorder is used.

\*\*The reception range may vary depending on various factors: obstacles, other Wi-Fi networks.

## FEATURES

- Microbolometer with a resolution of 384x288 pixels
- Microbolometer pixel size of 17 microns
- 1024x768 AMOLED display resolution
- Compact size
- Easily converts daylight optical riflescopes into thermal imaging riflescopes
- Preserves the benefits of daylight optics in night-time conditions
- Three calibration modes (manual, semi-automatic and automatic)

- Four observation modes: Forest, Rocks, Identification, User
- Detection distance up to 900 m
- Wireless remote control
- Instant start
- Display Off function
- Built-in video recording
- Remote firmware update
- Fully watertight (IPX7 protection class)
- Wide operating temperature range (-25 °C – +50°C)
- All-metal body made of light-alloy metal

#### **Video/audio Recording**

- Built-in video recorder
- Integration with iOS and Android devices
- Wi-Fi Smartphone remote control and surveillance
- YouTube Live broadcasting and direct recording on the Internet via a smartphone and the Stream Vision app.

#### **Battery Pack**

- Quick-change APS 5 Li-ion battery pack
- USB Power Bank charging option



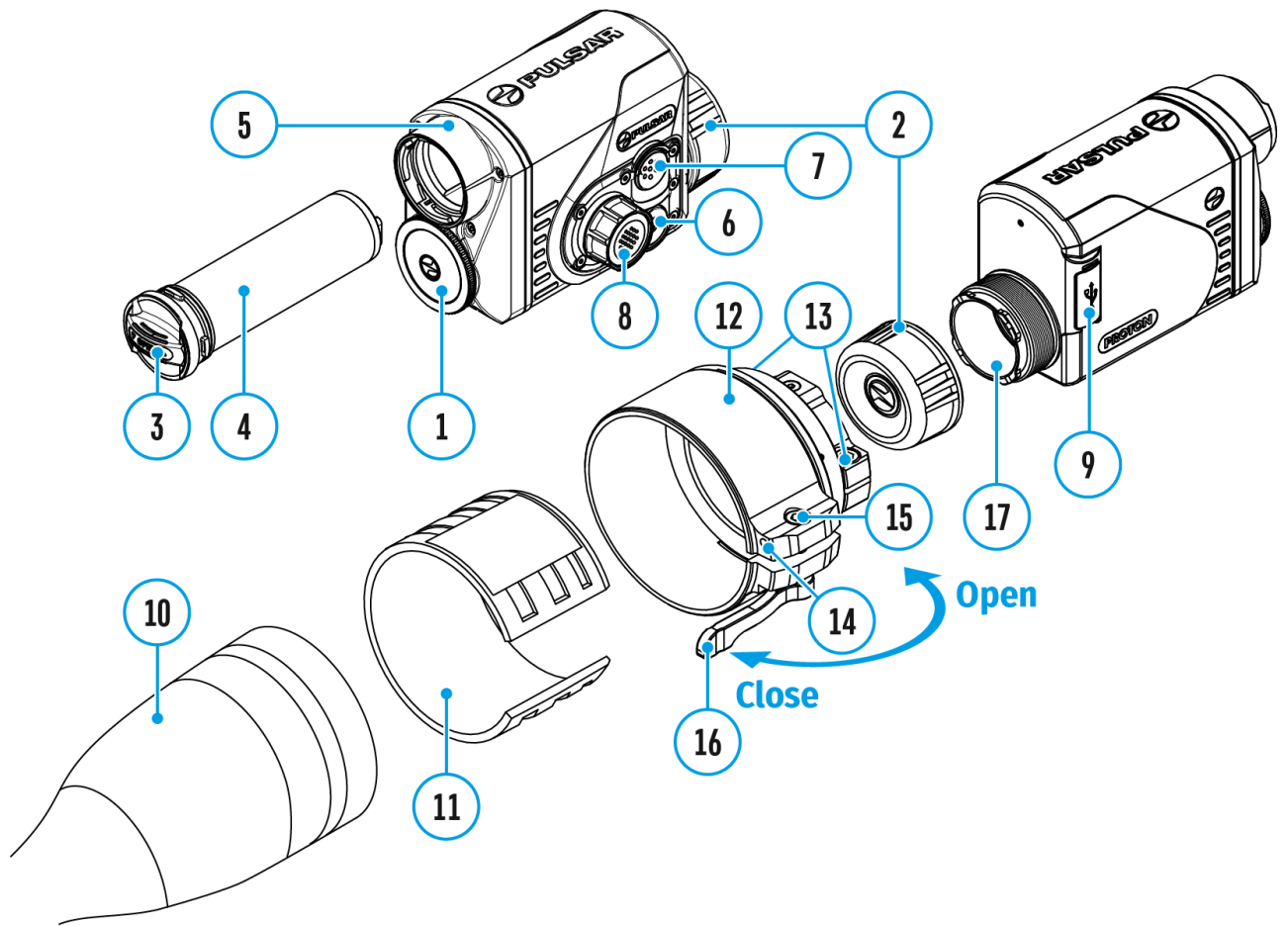











## COMPONENTS AND CONTROLS



1. Lens cover
2. Eyepiece cover
3. Battery compartment cover
4. Battery pack
5. Battery compartment
6. ON/OFF button
7. REC button
8. Controller
9. USB port
10. Objective lens end of daylight optical device
11. Insert

12. Adapter
13. Screws
14. Tightening screw
15. Screw
16. Adapter lever
17. Mounting area

## BUTTON OPERATION

<b>Operation</b>	<b>Button</b>
Power device on	 short press
Power device off	 long press for 3 secs
Turn display off	 long press for less than 3 secs
Turn display on	 short press
Calibrate the microbolometer	 short press
<b>Video Recorder</b>	<b>Button</b>
Start/pause/resume video recording	<b>REC</b> short press
Stop video recording	<b>REC</b> long press
Switch to video / photo mode	<b>REC</b> long press
Capture Photo	<b>REC</b> short press
<b>Main Menu</b>	<b>Button</b>
Enter main menu	 long press
Navigation through menu	 rotation
Enter menu items	 short press
Confirm value	 short press
Exit menu items	 long press
Exit main menu	 long press
<b>Quick Menu</b>	<b>Button</b>
Enter quick menu	 short press
Switch between quick menu options	 short press
Parameter change	 rotation

## USING THE BATTERY PACK

### BATTERY CHARGING

The **Proton FXQ30** thermal imaging attachment comes with an APS 5 rechargeable Lithium-ion battery. APS 5 batteries support USB Power Delivery fast charging technology when using a standard charging set (charger, USB Type-C cable, power adapter). Before first use, make sure the battery is fully charged.

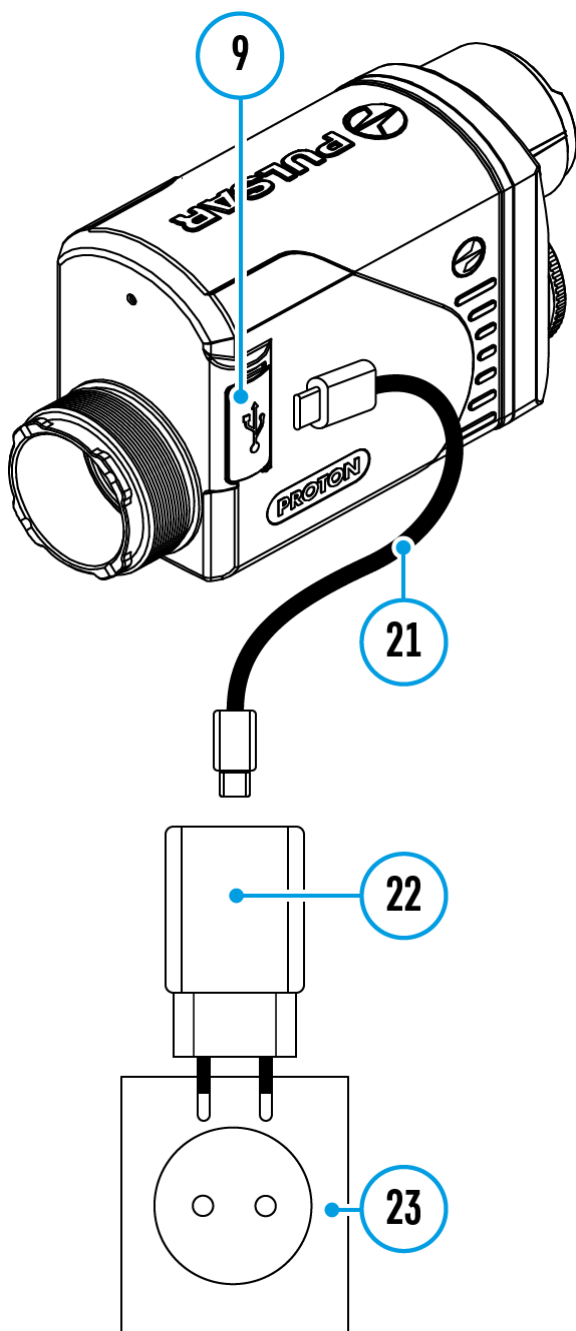



### **Option 1**



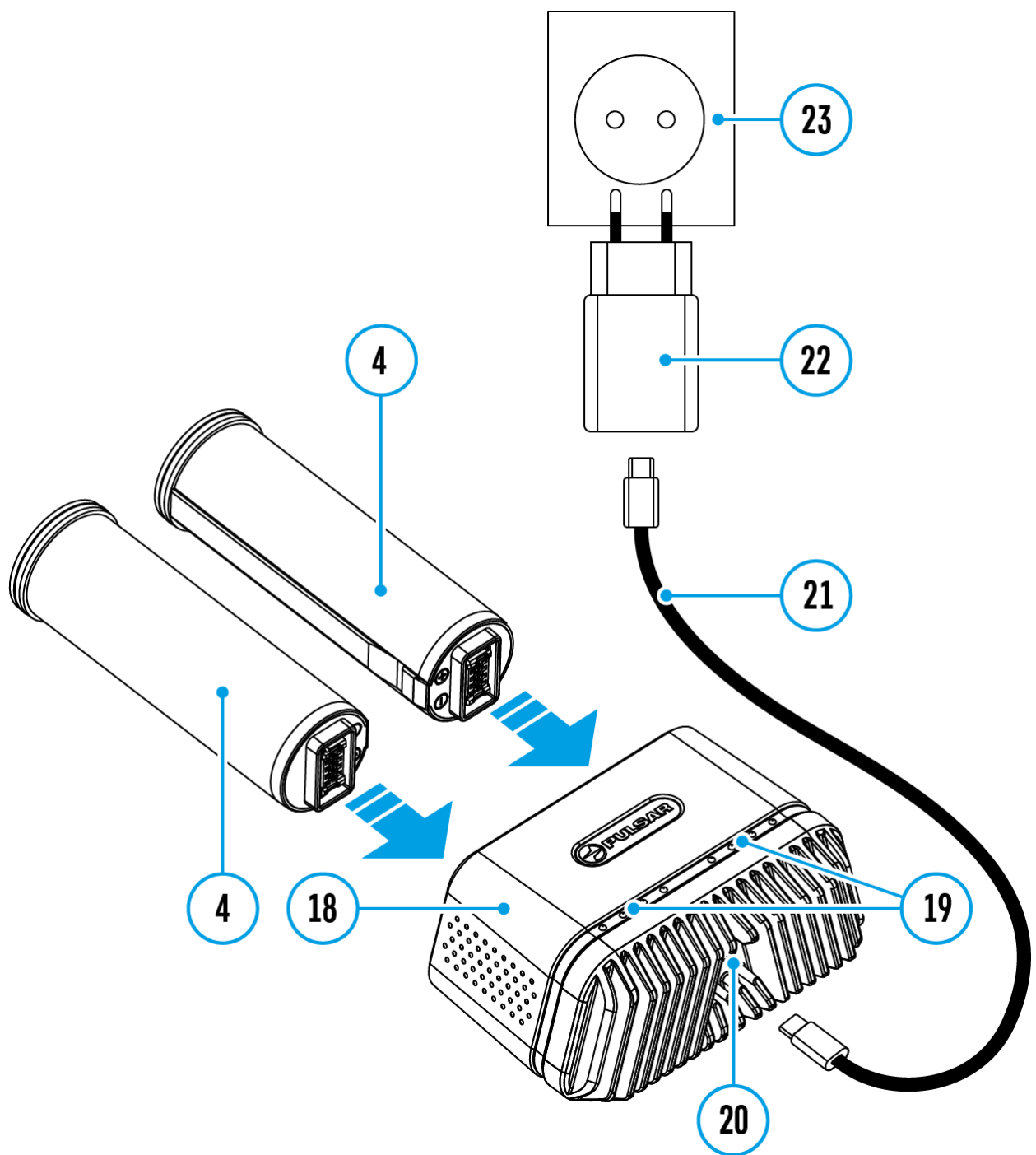









1. Install the APS 5 battery **(4)** in the battery compartment **(5)** of the device.
2. Connect the USB cable **(21)** to the USB Type-C connector **(9)** of the device.
3. Connect the other end of the USB cable **(21)** to the Power Adapter **(22)**.
4. Plug the Power Adapter **(22)** into a 100-240 V socket **(23)**.



### Option 2

1. Insert the APS 5 battery **(4)** along the guide into the APS 5 charger **(18)** slot as far as it will go. The APS charger is supplied with your device and sold separately.
2. Connect the plug of the USB Type-C cable **(21)** to the USB Type-C connector of the Power Adapter **(20)**.
3. Plug the Power Adapter **(22)** into a 100-240 V socket **(23)**.
4. Connect the other end of the USB Type-C cable **(21)** to the USB Type-C connector **(20)** of the charger.
5. LED indicators **(19)** will display the battery charge level (see Table).

**Note:** Two batteries can be charged at the same time, a second slot is provided for it.

LED indication (19) in the battery charging mode	Battery Level
	Battery charge level is from 0% to 25%
	Battery charge level is from 26% to 50%
	Battery charge level is from 51% to 80%
	Battery charge level is from 81% to 99%
	Battery is fully charged. It can be disconnected from the charger.
	Defective battery. <b>Do not use the battery!</b>
LED indication (19) in the standby mode*	Battery Level
	Battery charge level is from 0% to 25%
	Battery charge level is from 26% to 50%
	Battery charge level is from 51% to 80%
	Battery charge level is from 81% to 99%
	Battery is fully charged. It can be disconnected from the charger.
	Defective battery. <b>Do not use the battery!</b>

\* Standby mode is when the batteries are in the charger but the Power Adapter is not connected. In this mode, the indicators are only on for 10 seconds.

**Attention!** When using a Power Adapter that does not support USB Power Delivery fast charging technology, the flicker frequency of the LED indicators decreases by a factor of 3 and the charge time increases.

**Attention!** The charger heats up during fast charging. Excess heat is removed through the radiator and does not affect the device operation.

## BATTERY INSTALLATION

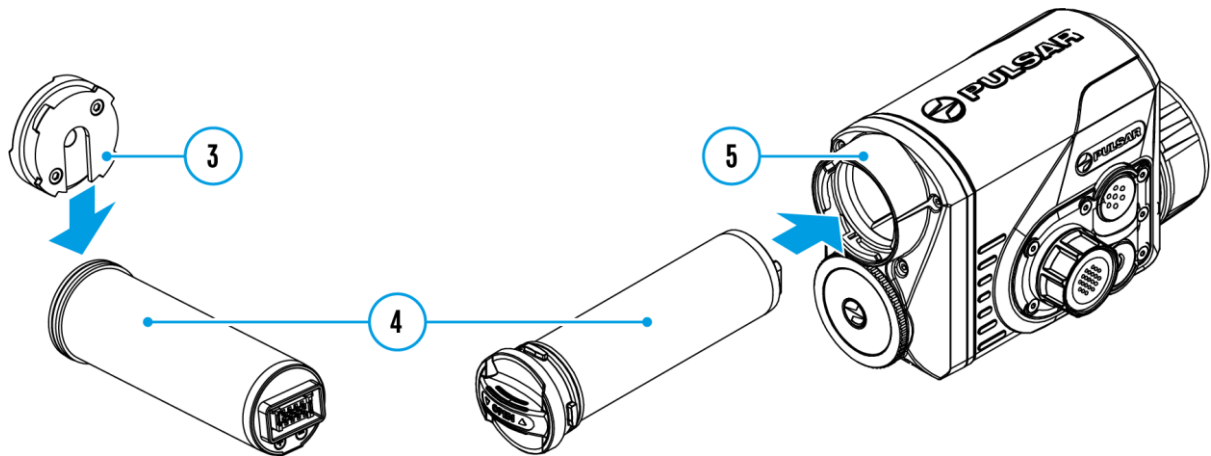

1. Put the Lock-cover **(3)** on the rechargeable APS 5 battery **(4)**.
2. Insert the APS 5 battery **(4)** along the guide into the battery compartment **(5)**.
3. Lock the battery **(4)** by turning the Lock-cover **(3)** clockwise until it stops.
4. Turn the Lock-cover **(3)** counter-clockwise to remove the battery **(4)**.

## PRECAUTIONS

- Always use the APS 5 charger supplied with the device (or purchased separately) to charge APS 5 batteries. Using an unsuitable charger can cause irreparable damage to the battery and fire.
- Do not charge the battery immediately after bringing it from cold to warm. Wait at least 30 minutes for the battery to warm up.
- Do not leave the battery unattended while charging.
- Do not use the charger if it has been modified or damaged.
- Do not leave the battery in a charger connected to the mains after charging is complete.
- Do not expose the battery to high temperatures or naked flames.
- Do not use the battery as a power source for devices that do not support APS 5 batteries.
- Do not disassemble or deform the battery or charger.
- Do not drop or strike the battery or charger.
- The battery and charger must not be immersed in water.



- Keep the battery out of the reach of children.

#### RECOMMENDATIONS FOR USE

- The batteries should be partially charged (50 to 80 %) for long-term storage.
- The battery is to be charged at an ambient temperature of 0°C to +35°C or the lifespan of the battery will decrease significantly.
- When using the battery at sub-zero ambient temperatures, the battery capacity decreases. This is normal and not a defect.
- Do not use the battery at temperatures outside the range of -25°C to +50°C or it may reduce battery life.
- The battery is short circuit protected. However, any situation that may cause short-circuiting should be avoided.

#### EXTERNAL POWER SUPPLY

External power can be supplied from an external source, such as a Power Bank (5 V).

1. Connect the external power source to the USB Type-C connector **(9)** on the device.
2. The device will switch to draw power from the external source while the APS5 battery will be gradually recharged.
3. A battery icon  will appear on the display showing the percentage charge level.
4. An icon  will be displayed when the device is powered by an external power source and the APS5 battery is not connected.
5. The device automatically switches to the APS 5 battery when the external power supply is disconnected.

**Attention!** Charging APS 5 batteries from an external source at temperatures below 0°C can reduce battery life. When using external power, connect the Power Bank to the device only after it has been turned on and working for at least several minutes.

## OPERATION

### MOUNTING ATTACHMENT ON OPTICAL RIFLESCOPE

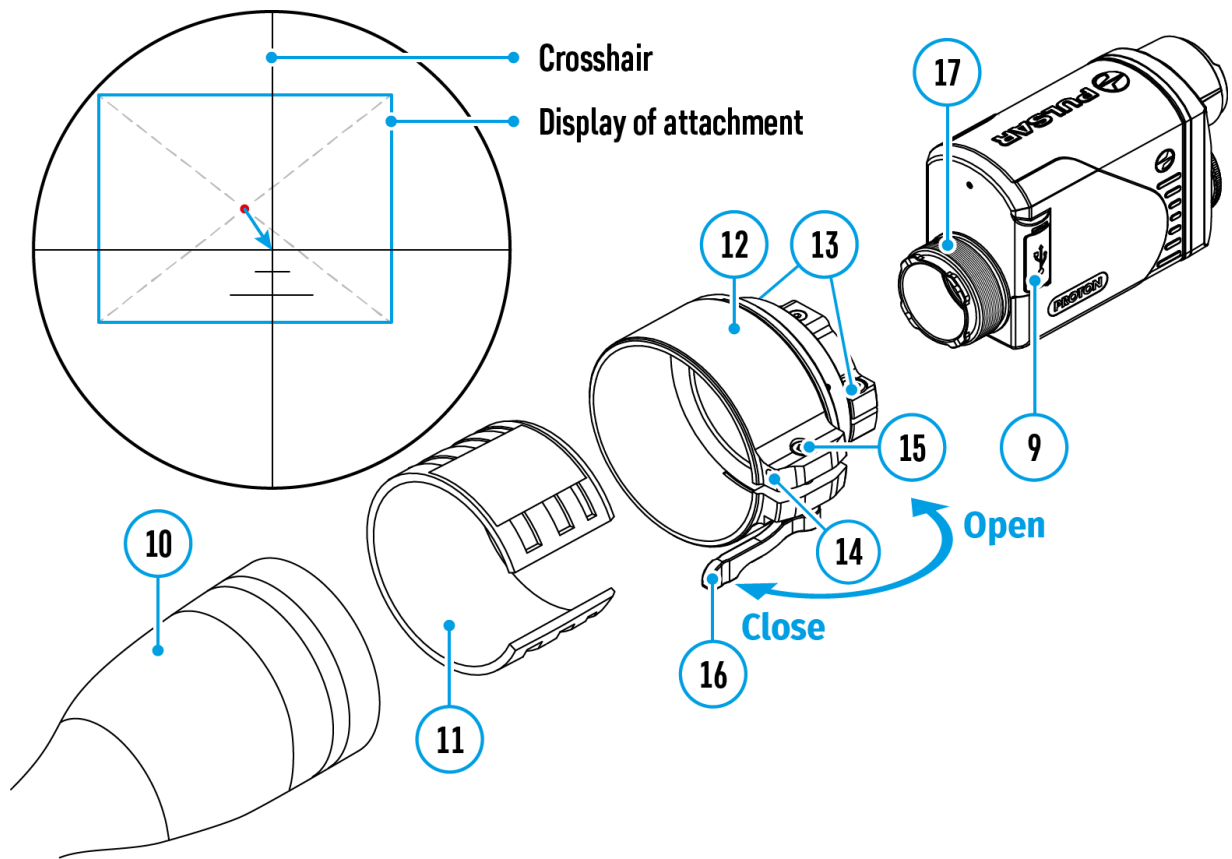

1. Remove the eyepiece cover **(2)**.
2. Select the Ring Adapter **(12)** (sold separately) with the insert **(11)** of the required diameter depending on the outer diameter of the lens of your rifle scope **(10)** (see [Table](#)). The designation 42 mm / 50 mm / 56 mm in the name of the adapter means the lens diameter of the rifle scope.
3. Screw together the Ring Adapter **(12)** and the attachment along the threads of the mounting area **(17)** until it stops. Then untighten a little (no more than one turn) so that the lever **(16)** is on the right side (see Figure).
4. Evenly tighten the screws **(13)** until the ball joint grips in the Ring Adapter **(12)**.
5. Apply 2-3 strips of double-sided tape to the outer surface of the insert **(11)** of your choice.
6. Push the insert **(11)** of your choice into the Ring Adapter **(12)** until it stops.
7. Move the lever **(16)** to the OPEN position.
8. Before installing the Ring Adapter **(12)** onto the rifle scope, it is recommended to degrease the lens body of the rifle scope **(10)**.

9. Mount the Ring Adapter **(12)** with the insert **(11)** onto the lens of the daylight riflescope **(10)** as far as it will go.
10. If the Ring Adaptor **(12)** with the insert **(11)** selected according to the table cannot be mounted onto the lens **(10)**, follow the steps below:
  - Loosen the locking screw **(14)** with a 2mm Allen key.
  - Untighten the screw **(15)** with a hex wrench (S = 4mm) until the Ring Adaptor with the insert can be mounted onto the lens **(10)**.
11. Move the lever **(16)** from its initial OPEN position to the CLOSE position.
12. Loosen the locking screw **(14)** with a 2mm Allen key, if it hasn't been done before.
13. Tighten the screw **(15)** using a 4mm Allen key. The clamping force should be 1.5-2 Nm (use a torque screwdriver) to ensure the lever is correctly tightened **(16)**, while the Ring Adapter with the attachment should not move relative to the body of the riflescope **(10)**. If necessary, tighten or loosen the screw **(15)** to operate the lever **(16)** in the best way possible.
14. Tighten the locking screw **(14)** as far as it will go.
15. Turn on the attachment by briefly pressing the **ON/OFF (6)** button.
16. Align the display center with the crosshairs of the reticle by tilting the attachment.
17. Align top and bottom display boundaries parallel to the horizontal axis of the riflescope by turning the attachment clockwise or counterclockwise.
18. Having reached the best possible position of the attachment, tighten the two screws **(13)** until stop. The clamping force should be 5-7.5 N·m (use a torque screwdriver to check).

*Selection Table for Riflescope Inserts*

Ring Adapter model	The internal diameter of the insert needs to match the outer diameter of the objective lens housing of the riflescope it is being installed on.	
	Insert internal diameter, mm	Suitable for lens housing of riflescopes with an outer diameter of, mm
PSP Ring Adapter 42 mm	45.5	45.5
	46	46
	46.5	46.5
	47	46.7-47.6
	48	47.7- 48.6

	49	48.7-49.6
	50	49.7-50.6
PSP Ring Adapter 50 mm	51.6	51.6
	53.4	53.4
	55	54.7-55.6
	56	55.7-56.6
	57	56.7-57.6
	58	57.7-58.6
	59	58.7-59.6
PSP Ring Adapter 56 mm	60	59.7-60.6
	61	60.7-61.6
	62	61.7-62.6
	63	62.7-63.6
	64	63.7-64.6
	65	64.7-65.6

## POWERING ON AND IMAGE SETTING

1. Remove the lens cover **(1)**.
2. Press the **ON/OFF (6)** button to turn on the attachment.
3. If necessary, adjust the reticle sharpness according to the instructions for your scope.
4. Enter the main menu with a long press of the controller button **(8)** and select the desired calibration mode: **manual (M)**, **semi-automatic (SA)** or **automatic (A)**.
5. Calibrate the image by briefly pressing the **ON/OFF (6)** button. Close the lens cover before manual calibration.
6. Select the desired observation mode (**Forest, Rocks, Identification** or **User**) in the main menu. User mode allows you to change and save user brightness and contrast settings in the quick menu.
7. Enter the main menu with a long press of the controller button **(8)** and select the desired color palette (see the **Color Modes** section).
8. Activate the quick menu by briefly pressing the controller button **(8)** to adjust the brightness and contrast of the display (see the **Quick Menu Functions** section).
9. Upon completion of use turn the device off by a long press of the **ON/OFF (6)** button.



**Warning!** Never point the lens at intensive energy sources such as laser radiation emitting devices or the sun. It can damage electronic components in the device. The warranty does not cover damage arising from failure to comply with the operating rules.

## MICROBOLOMETER CALIBRATION

Calibration enables the microbolometer temperature background to be equalized and defects in the image (such as vertical lines, phantom images etc.) to be eliminated.

During calibration, the image on the display freezes briefly for up to 1 second.

There are three calibration modes: **manual (M)**, **semi-automatic (SA)** and **automatic (A)**.

Select the required mode in the **Calibration Mode**  section of the menu.

### **M mode (manual).**

- Secure the lens cover **(1)** and briefly press the **ON (6)** button.
- After completing the calibration process, remove the lens cap.

### **SA mode (semi-automatic)**

- Calibration is engaged by a brief press of the **ON (6)** button.
- The lens cap does not need to be secured (the microbolometer is closed by an internal shutter).

### **A mode (automatic)**

- The device is calibrated autonomously, in accordance with the firmware algorithm.
- The lens cap does not need to be secured (the microbolometer is closed by an internal shutter).
- In this mode, the device may be calibrated by the user using the **ON (6)** button.

## IMAGE DETAIL BOOST

The **Image Detail boost**  function increases the sharpness of the contours of heated objects, which increases their detail. The result of the function depends on the selected mode and observation

conditions: the higher the contrast of objects, the more noticeable the effect. This option is enabled by default, but can be disabled in the main menu.

The description of enabling/disabling the **Image Detail Boost** function is available [here](#).

## STATUS BAR



The status bar is at the bottom of the display and displays information on the actual operating status of the device, including:

- Color Mode (shown only when the Black Hot color mode is selected)
- Auto shutdown function (for example, 1 min)
- Microphone
- Calibration Mode (in Automatic calibration mode a countdown timer will appear instead of the calibration mode icon 3 seconds before automatic calibration begins).

- Power Indication:

 - charge level if the device is powered by a battery

 - charge level if the device is charging and powered by a battery

 - no battery, the device is connected to an external power supply.

- Observation Mode
- Video recording status:

 - video recording is on

 - pause

 - video recording is off

- Wi-Fi Connection

- Time
- Bluetooth

## QUICK MENU FUNCTIONS

- Enter the menu with a short press of the controller button **(8)**.
- To select the functions below, press successively the controller button **(8)**.

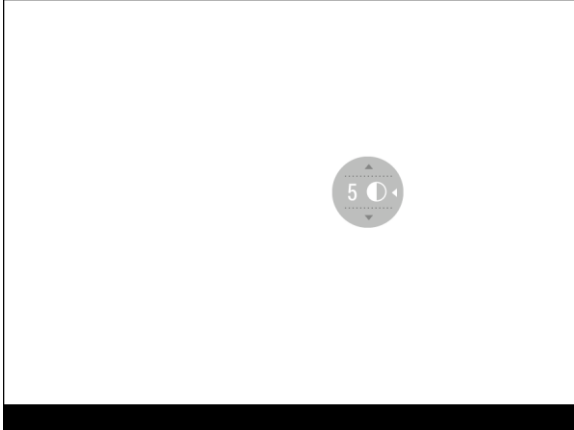

**Contrast**  – rotate the controller ring **(8)** to change the display contrast value from 0 to 20.

**Brightness**  – rotate the controller ring **(8)** to change the display brightness value from 0 to 20.

**Basic mode**  – it allows you to select one of the three observation modes (Forest, Rocks, Identification) as the basic one for the user mode.

- To exit the menu, press and hold down the controller button **(8)**, or wait 10 seconds for automatic exit.

## MAIN MENU FUNCTIONS

### ENTER THE MAIN MENU

1. Enter the menu with a long press of the controller button **(8)**.
2. Rotate the controller ring **(8)** to move through the menu functions.
3. One short press of the controller button **(8)** opens a menu item.
4. To exit the menu, press and hold down the controller button **(8)**.

Automatic exit from the menu occurs after 10 seconds of inactivity.

**General view of the menu:**

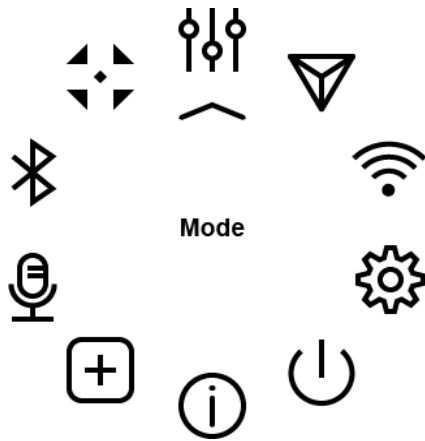



## MODE

### Observation mode selection

The device has four observation modes of the thermal imager: Forest (observation mode of objects within low thermal contrast conditions), Rocks (observation mode of objects within high thermal contrast conditions), Identification (high detailization mode), and User (individual brightness and contrast settings).

1. Press and hold the controller button **(8)** to enter the menu.
2. Rotate the controller ring **(8)** to select the **Mode**  menu item.
3. A short press of the controller button **(8)** opens the menu.
4. Rotate the controller ring **(8)** to select one of the modes: Forest, Rocks, Identification, and User.
5. A short press of the controller button **(8)** confirms the selection.

 **Rocks.** This is the best mode when observing objects after a sunny day or within urban conditions.

 **Forest.** This is the best mode when searching and observing within field conditions, against the background of leaves, bushes and grass. The mode is highly informative about an object being observed as well as landscape details.

 **Identification.** This is the best mode when observing objects within adverse weather conditions (fog, mist, rain and snow). It allows you to recognize the characteristics of an object being observed more clearly. Increased detail may be accompanied by insignificant image graininess.



**User.** It allows you to configure and save custom brightness and contrast settings, as well as one of the three modes (Forest, Rocks, Identification) as a base.

## IMAGE DETAIL BOOST

Turn on/off Image Detail Boost

1. Press and hold the controller button **(8)** to enter the menu.
2. Rotate the controller ring **(8)** to select the **Image Detail Boost**  menu item.
3. A short press of the controller button **(8)** opens the submenu.
4. To turn Image Detail Boost on or off press the controller button **(8)**.

## WI-FI SETTINGS

This menu option allows you to set up your device for operation in a Wi-Fi network.

1. Press and hold the controller button **(8)** to enter the menu.
2. Rotate the controller ring **(8)** to select the **Wi-Fi Settings**  menu item.
3. A short press of the controller button **(8)** opens the menu section.

### *Wi-Fi Activation*

Turn Wi-Fi on/off.

1. Rotate the controller ring **(8)** to select the **Wi-Fi Activation**  menu item
2. A short press of the controller button **(8)** opens the submenu.
3. To turn Wi-Fi on or off press the controller button **(8)**.

### *Password Setup*

This submenu allows you to set a password to access your thermal riflescope from a mobile device.

1. Rotate the controller ring **(8)** to select the **Password Setup**  menu item
2. A short press of the controller button **(8)** opens the submenu.
3. The default password **(12345678)** will appear on the screen.

4. Rotate the controller ring **(8)** to set your desired password. Press the controller button **(8)** to toggle the digits.
5. Press and hold down the controller button **(8)** to save the password and exit the submenu.

### *Access Level Setup*

This submenu allows you to set access levels of Stream Vision application to your device.

- Access level **Owner**. Stream Vision user has complete access to all device's functions.
- Access level **Guest**. Stream Vision user has access only to real time video stream from the device.

1. Rotate the controller ring **(8)** to select the **Access Level Setup**  menu item.
2. A short press of the controller button **(8)** opens the submenu.
3. Rotate the controller ring **(8)** to select **Owner** or **Guest**.
4. Confirm your selection with a short press of the controller button **(8)**.

### GENERAL SETTINGS

This menu section allows you to change the interface language, set the date, time, units of measure, return the device to factory default settings and perform memory card formatting.

1. Press and hold the controller button **(8)** to enter the menu.
2. Rotate the controller ring **(8)** to select the **General Settings**  menu item.
3. A short press of the controller button **(8)** opens the submenu.

### *Icon Brightness*

Adjust brightness level of the icons and screensavers (Pulsar, Display off) on the display.

1. Rotate the controller ring **(8)** to select the **Icon Brightness**  icon.
2. Press the controller button **(8)** briefly to enter the submenu.
3. Rotate the controller ring **(8)** to select the desired brightness level from 0 to 10.
4. Press the controller button **(8)** briefly to confirm the selection.

## Language

### Language selection

1. Rotate the controller ring **(8)** to choose **Language**  menu item.
2. Press the controller button **(8)** briefly to confirm the selection.
3. Rotate the controller ring **(8)** to select one of the available interface languages: English, German, Spanish, French, and Russian.
4. Press the controller button **(8)** briefly to confirm the selection.

## Auto Shutdown

This item allows you to activate the auto shutdown function for when the device is in a non-operating position (tilted up or down at an angle of more than 70°, right or left at an angle of more than 30°).

1. Rotate the controller ring **(8)** to choose **Auto Shutdown**  menu item.
2. Press the controller button **(8)** briefly to confirm the selection.
3. Rotate the controller ring **(8)** to select the time period (1 min, 3 min, 5 min) upon expiry of which the device will automatically shut down, or select Off if you wish to deactivate Auto Shutdown.
4. Press the controller button **(8)** briefly to confirm the selection.

**Note:** If the Auto Shutdown function is activated, the status bar shows an icon and shutdown time period as  1 min.

## Date

### Date setup

1. Rotate the controller ring **(8)** to choose **Date**  menu item.
2. Press the controller button **(8)** briefly to confirm the selection. The date appears in dd/mm/yyyy format (01/01/2021).

3. Rotate the controller ring **(8)** to set the required year, month and day. Press the controller button **(8)** to toggle the digits.
4. To save your chosen date and exit the submenu, press and hold the controller button **(8)**.

### *Time*

#### Time setup

1. Rotate the controller ring **(8)** to choose **Time**  menu item.
2. Press the controller button **(8)** briefly to confirm the selection.
3. Rotate the controller ring **(8)** to select the time format (24-hour clock or AM/PM).
4. Switch to hour setup with a short press of the controller button **(8)**.
5. Select hour value with a short press of the controller button **(8)**.
6. Switch to minute setup with a short press of the controller button **(8)**.
7. Select minute value with a short press of controller button **(8)**.
8. Save selected time value and exit the submenu with a long press of the controller button **(8)**.

### *Default Settings*

#### Restore default settings

1. Rotate the controller ring **(8)** to choose **Default Settings**  menu item.
2. Press the controller button **(8)** briefly to confirm the selection.
3. Rotate the controller ring **(8)** to select Yes to restore default settings or No to cancel.
4. Confirm your selection with a short press of the controller button **(8)**.
  - If Yes is selected, display will show "**Do you want to restore default settings?**" and **Yes** and **No**. Select **Yes** to restore the default settings.
  - Selecting the **No** option will cancel the reset and exit the submenu.

The following settings will be returned to their defaults before being changed by the user:

- **Video Recorder Mode** – Video



- **Observation Mode** – Forest
- **Calibration Mode** – Automatic
- **Language** – English
- **Wi-Fi** – Off (default password)
- **Color Mode** – White Hot

**Attention!** When restoring the factory defaults the date, time and user pixel map are saved.

### *Format*

This function enables you to format the Flash memory card. All files will be deleted.

1. Rotate the controller ring **(8)** to choose **Format**  menu item.
2. Press the controller button **(8)** briefly to confirm the selection.
3. Rotate the controller ring **(8)** to select Yes to format the memory card or No to return to the submenu.
4. Press the controller button **(8)** briefly to confirm your selection.
- If Yes is selected, the message "**Do you want to format the memory card?**" appears on the display as well as **Yes** and **No**. Select **Yes** to format the memory card.
- Selecting the **No** option will cancel the formatting and exit the submenu.

### COLOR MODES

Color palette selection

**White Hot** is the default display mode. To select an alternative palette, do the following:

1. Press and hold the controller button **(8)** to enter the main menu.
2. Rotate the controller ring **(8)** to select **Color Modes**  icon.
3. Press the controller button **(8)** briefly to enter the submenu.
4. Rotate the controller ring **(8)** to select the desired palette.
5. Press the controller button **(8)** briefly to confirm the selection.

**Black Hot** – a black and white palette where white corresponds to cold temperatures and black to hot temperatures.

**Red Hot**

**Red Monochrome**

**Rainbow**

**Ultramarine**

**Violet**

**Sepia**

## DEVICE INFORMATION

This menu item allows the user to view the following information about the device:

- SKU Number
- Firmware Version
- Device Name
- Hardware Version
- Device Serial Number
- Service Information

To display information, do the following:

1. Press and hold the controller button **(8)** to enter the main menu.
2. Rotate the controller ring **(8)** to select the **Device Information**  icon.
3. Press the controller button **(8)** briefly to view / exit the information.





## DEFECTIVE PIXEL REPAIR

### DEFECTIVE PIXEL REPAIR

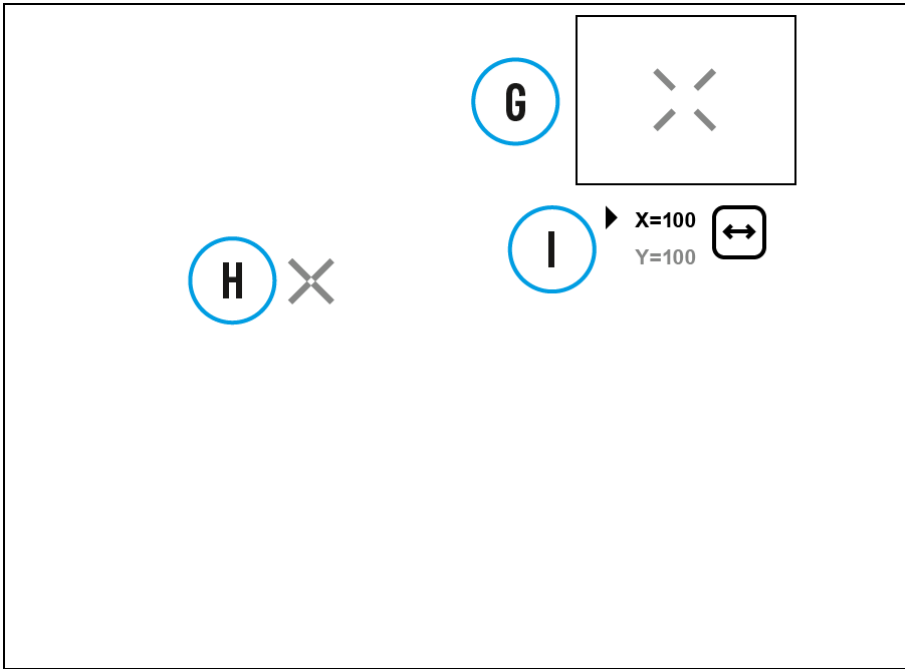
When using the device, defective (dead) pixels may appear on the microbolometer. These are bright or dark points of a constant brightness that are visible on the image.



**Proton FXQ30** thermal imaging attachments allow the user to remove any defective pixels on the sensor using firmware as well as to cancel removing.



1. Press and hold the controller button **(8)** to enter the main menu.
2. Rotate the controller ring **(8)** to select the **Defective Pixel Repair**  icon.
3. Press the controller button **(8)** to enter the submenu.
4. Select the **Defective Pixel Repair**  option by briefly pressing the controller button **(8)**.
5. A marker **(H)**  will appear on the left side of the display.
6. A magnifying glass **(G)** will appear on the right side of the display – a rectangle with an enlarged view of the marker  for precise pixel selection – and the coordinates **(I)** of the marker under the magnifying glass.
7. Rotate the controller ring **(8)** to align a defective pixel with the center of the enlarged marker in the magnifying glass – the pixel should be removed. Press the controller button **(8)** briefly to switch the marker direction between the horizontal to the vertical.
8. Press the **ON (6)** button briefly to delete the dead pixel.
9. Once the pixel has been successfully deleted, an OK message will briefly appear on the screen.
10. You can then delete the next defective pixel if required by moving the marker across the display.

## RESTORE DEFAULT PIXEL MAP

This option allows the user to return all previously disabled defective pixels to their original state.

1. Press and hold the controller button **(8)** to enter the main menu.
2. Rotate the controller ring **(8)** to select the **Defective Pixel Repair**  icon.
3. Press the controller button **(8)** to enter the submenu.
4. Rotate the controller ring **(8)** to select the **Restore Default Pixel Map**  icon .
5. Activate the function by briefly pressing the controller button **(8)**.
6. Rotate the controller ring **(8)** to select Yes if you want to return to the factory pixel map or select No if you do not.
7. Confirm your selection with a short press of the controller button **(8)**.

**Attention!** One or two pixels on the display of the device in the form of bright white, black or colored (blue, red or green) points may appear. These points cannot be removed and are not a defect.

## MICROPHONE

Turning microphone on / off.

This item allows you to enable (or disable) the microphone for recording sound during video recording.

1. Press and hold the controller button **(8)** to enter the main menu.
2. Rotate the controller ring **(8)** to select **Microphone**  icon.
3. A short press of the controller button **(8)** opens the submenu.
4. To turn the microphone on or off press controller button **(8)**.

## BLUETOOTH

Turn on/off Bluetooth

1. Press and hold the controller button **(8)** to enter the main menu.
2. Rotate the controller ring **(8)** to select the **Bluetooth**  menu item.
3. A short press of the controller button **(8)** opens the submenu.

4. Turn Bluetooth on/off with a short press of the controller button **(8)**.
5. Press and hold down the controller button **(8)** to exit the submenu.

The process of connecting the wireless remote control is described in the [Remote Control Activation](#) section.

## CALIBRATION MODE

Calibration mode selection

There are three calibration modes: **Manual**, **Semi-Automatic** and **Automatic**.

1. Press and hold the controller button **(8)** to enter the main menu.
2. Rotate the controller ring **(8)** to select the **Calibration Mode**  icon.
3. Press the controller button **(8)** briefly to enter the submenu.
4. Rotate the controller ring **(8)** to select one of the calibration modes described below.
5. Press the controller button **(8)** briefly to confirm the selection.

**Automatic (A).** In this mode the firmware determines the need for calibration. The calibration process starts automatically.

**Semi-Automatic (SA).** The user determines the need for calibration based on the image quality and can action at a convenient time depending on the object being observed.

**Manual (M).** In the Manual (silent) calibration mode the user determines the need for calibration (as in **SA** mode) but the lens cover must be closed during calibration.

## VIDEO RECORDING AND PHOTOGRAPHY

The **Proton FXQ30** thermal imaging attachments are equipped with the option to record video and still images (photography) of the observed image by saving them on the built-in memory card.

It is recommended to set the **date** and **time** (see the [General Settings](#) section) before using the photo and video functions.

The built-in recorder operates in two modes:

## Video mode. Video Recording

1. The **Video** mode is activated when you turn on the device.
2. The icon  and the remaining recording time in HH:MM (Hours:Minutes) format are displayed in the upper left corner, for example, 5:12. In the status bar, the video recording status is displayed continuously.
3. Press the **REC (7)** button briefly to start video recording.
4. When the video recording starts, the icon will disappear and the REC icon and timer in MM:SS (Minutes:Seconds) format will appear.
5. Press the **REC (7)** button briefly to pause or resume video recording.
6. Press and hold the **REC (7)** button to stop video recording.
7. Video files are saved to the built-in memory card after the video recording has been stopped.
8. Switch between modes (**Video**-> **Photo**-> **Video**) with a long press of the **REC (7)** button.

## Photo mode. Capturing a photo

1. Switch to **Photo** mode by pressing and holding the **REC (7)** button.
2. Press the **REC (7)** button briefly to take a photo. The image freezes for 0.5 sec while the photo is saved to the internal memory.

### Notes:

- You can enter and navigate the menu during video recording.
- The recorded videos and photos are saved to the built-in memory card of the device in the formats img\_xxx.jpg (photos) and video\_xxx. mp4 (video) where xxx is a 3 digit counter.
- The counter for multimedia files cannot be reset.

### Attention!

- The maximum duration of a recorded video file is five minutes. After this time expires, the video is recorded to a new file.
- The number of recorded files is limited by the capacity of the internal memory of the device.





- Regularly check the free capacity of the internal memory and move recorded footage to other storage media to free up space on the internal memory card.



## WI-FI FUNCTION

The device has a function enabling wireless communication with external devices (smartphone or tablet) via Wi-Fi.

- Turn on the wireless module in the **Wi-Fi Activation**  menu option (see [Wi-Fi Settings](#) section).

**Wi-Fi is displayed in the status bar as follows:**

Connection Status	Indication on the status bar
Wi-Fi is switched off	
Wi-Fi connection is in progress	
Wi-Fi is switched on, no connection with device	
Wi-Fi is switched on, device connected	

- The device is recognized by an external device as PROTON\_XXXX where XXXX are the four last digits of the serial number.
- After entering the password on the external device (see **Password Setup** subsection of the [Wi-Fi Settings](#) section for more information on setting a password) and setting up a connection, the icon  in the status bar changes to .

## DISPLAY OFF FUNCTION

This function deactivates the image transmission to the display by minimizing its brightness. This helps prevent accidental disclosure. However, the device stays on.

When this function is in use, the device switches to the standby mode, which allows it to be switched on quickly if necessary.

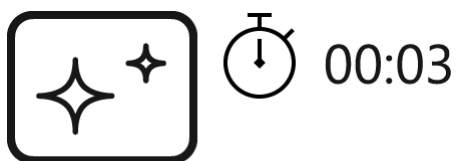

Display off

1. When the device is on, press and hold the **ON/OFF (6)** button for less than 3 seconds. The display goes blank and the message **Display Off**.
2. Press the **ON/OFF (6)** button briefly to turn on the display.
3. When you press and hold the **ON/OFF (6)** button, the display shows the message **Display Off** with a countdown. Holding the button down for the duration of the countdown will power the device off completely.

## DISPLAY CALIBRATION

The thermal imaging attachment is configured so that after it is being mounted onto an riflescope that has been correctly configured, no adjustment of the aiming point is required. If your attachment has been subjected to hard blow or has been dropped, you may check the impact point and adjust it yourself if required, without having to return it to a service centre.

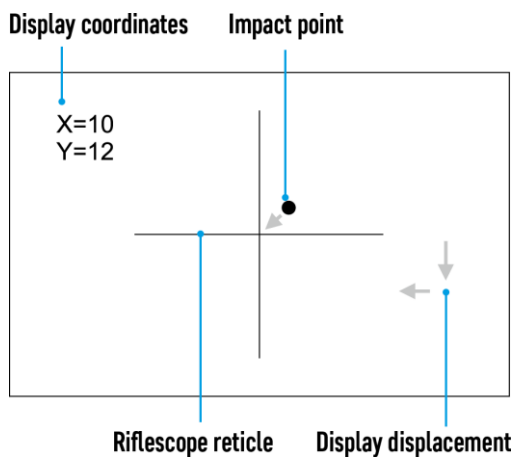

1. Press and hold the controller button **(8)** for 10 seconds to enter the display calibration mode – the coordinates X=0; Y=0 will appear.
2. Rotate the controller ring **(8)** to move the display horizontally (X axis) and vertically (Y axis) so that the point of impact moves to the centre of the aiming reticle of your riflescope.
3. Press the controller button **(8)** briefly to toggle between the X and Y coordinates.
4. The image shift range is +/-20 pixels for a horizontal axis (X axis) and +/-20 pixels for a vertical axis (Y axis).
5. To exit the menu and save the settings, press and hold the controller button **(8)** for two seconds.





## Wireless Remote Control

### Descriptions of Controls

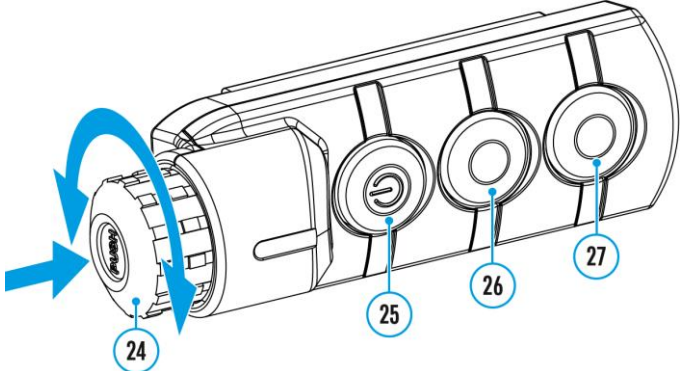
The wireless remote control duplicates the functions of turning off the device, turning off the display, calibration, switching observation modes and palettes, video recording and photographing, and it allows navigation through the menu.

		<b>Controller (24)</b>	<b>Button (25)</b>	<b>Button (26)</b>	<b>Button (27)</b>
<b>Short press</b>		Enter the quick menu and submenus of the main menu / confirm the selection / Switch to the next item of the quick menu	Turn the display on / Calibrate the microbolometer	Switch observation modes	Start video recording / Capture a photo
<b>Long press</b>		Enter/exit the main menu / Exit the quick menu	Turn the display off / Turn the device off	Turn on/off the Black Hot palette	Switch to photo/video mode
<b>Clockwise rotation</b>	<b>Quick menu</b>	Increase parameter			
	<b>Main menu</b>	Navigate downwards/clockwise			
<b>Counter-clockwise rotation</b>	<b>Quick menu</b>	Decrease parameter			
	<b>Main menu</b>	Navigate upwards/counterclockwise			

### Remote Control Activation

1. Turn on the Bluetooth module (see the [Bluetooth](#) section).
2. In the **Bluetooth**  section of the menu, use the controller ring **(8)** to select the **Scan**  menu item.
3. Confirm your selection with a short press of the controller button **(8)** button.
4. Press and hold any button on the Remote Control. The Remote Control is visible in the Bluetooth network and can be connected during this time.
5. Use the controller ring **(8)** to select the remote control from the dropdown list that appears.
6. Confirm your selection with a short press of the controller button **(8)** button.

### Notes:

- Once paired, the Remote Control can operate the Pulsar device.
- Going forward, the Remote Control will automatically connect to the paired device when within visible range.
- The name of the remote control and its battery charge level will appear in the list of paired devices at the bottom of the display in the **Bluetooth**  section of the menu.

## STREAM VISION

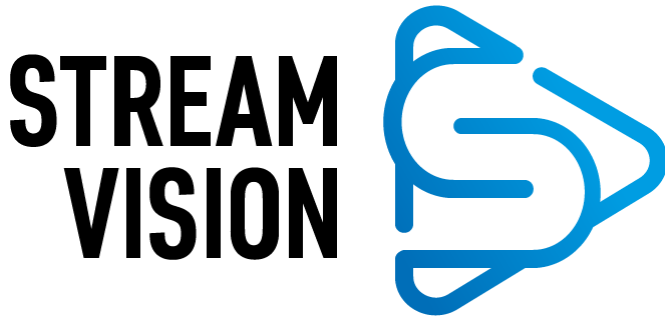

The **Proton FXQ30** thermal imaging attachments support Stream Vision technology, which enables the transmission of an image in real time from the attachment to your smartphone or tablet via Wi-Fi.

You can find further guidelines on Stream Vision [here](#).

[Download](#) from Google Play

[Download](#) from App Store

Find answers to frequently asked questions about using Stream Vision [here](#).

## FIRMWARE UPDATE

1. Download free of charge Stream Vision App on [Google Play](#) or [App Store](#).
2. Connect your Pulsar device to your mobile device (smartphone or tablet).
3. Launch Stream Vision and go to section "My Devices".
4. Select your Pulsar device and press "Check Updates".
5. Wait for the update to download and install. Pulsar device will reboot and will be ready to operate.

### **Important:**

- if your Pulsar device is connected to phone, please turn on mobile data transfer (GPRS/3G/4G) to download update;

- if your Pulsar device is not connected to your phone but it's already in the “My Devices” section, you may use Wi-Fi to download update.

### Is your firmware up to date?

Click [here](#) to check the latest firmware for your device.

## USB CONNECTION

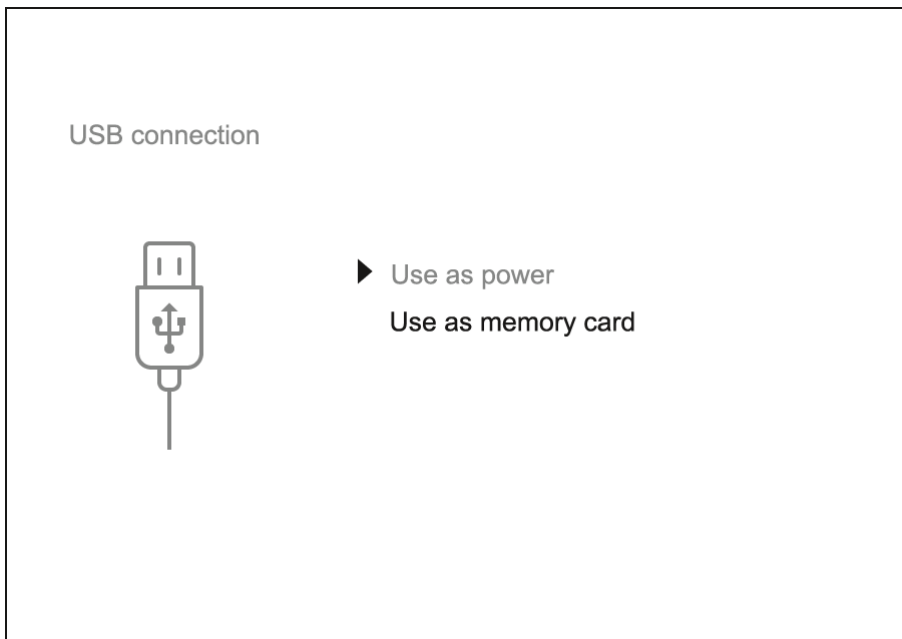

1. Connect one end of the USB cable to the device micro-USB port **(9)** and the other end to the port on your computer.
2. Switch the device on with a short press of the **ON/OFF (6)** button (the computer will not detect the device if it is switched off).
3. The device is detected by the computer automatically and no drivers need to be installed.
4. Two connection modes will appear on the display: **Use as power** and **Use as memory card**.
5. Rotate the controller ring **(8)** to select the connection mode.
6. Press the controller button **(8)** briefly to confirm the selection.

### Use as power

- When this mode is selected, the computer is used as an external power supply. The icon  appears in the status bar. The device will continue operating and all the functions are available.
- A battery installed in the device will not be charged.
- When disconnecting the USB from the device connected in **Use as power** mode, the device will continue to operate from the rechargeable battery if it is present and provided it has enough charge.

### **Use as memory card**

- When this mode is selected, the device is recognized by the computer as a flash card. This option is designed for working with files that are stored on the device's built-in memory. However, the device functions are not available in this mode and it will switch off automatically.
- If video recording was in progress when the connection was made, recording stops and the video is saved.
- When USB cable is disconnected from the device in **Use as memory card** mode, the device remains turned OFF. Press the **ON/OFF (6)** button to turn on the device.

## TECHNICAL INSPECTION

It is recommended to carry out a technical inspection before each use of the device. Check the following:

- The device appearance (there should be no cracks on the body).
- The state of the objective and eyepiece lenses of the attachment (there should be no cracks, grease spots, dirt or other deposits).
- The state of the rechargeable battery (it should be charged) and the electric contacts (there should be no signs of salts or oxidation).
- The controls should be in working order.
- The attachment is properly and firmly fixed on the riflescope.

## TECHNICAL MAINTENANCE AND STORAGE

Maintenance should be carried out at least twice a year and include the following steps:

- Wipe the exterior metal and plastic surfaces with a cotton cloth to remove dust and dirt.
- Clean the electrical contacts of the rechargeable battery on the device using a non-greasy organic solvent.
- Check the eyepiece and the lens and if required remove dust and dirt from the optics (preferably using a non-contact method). Cleaning of the exterior surfaces of the optics should only be done with products specifically designed for this purpose.
- Always store the device in its carrying case in a dry, well-ventilated space. For prolonged storage, remove the batteries.

## TROUBLESHOOTING

The device does not turn on

### **Possible cause**

The battery is completely discharged.

### **Solution**

Charge the battery.

The device does not operate from an external power source

### **Possible cause**

The USB cable is damaged.

### **Solution**

Replace the USB cable.

### **Possible cause**

The external power supply is discharged.

### **Solution**

Charge the external power supply (if necessary).

Blurred image with vertical stripes or an uneven background

### **Possible cause**

Calibration is required.

**Solution**

Perform image calibration according to the [Microbolometer Calibration](#) section of the manual.

Poor quality image. There is noise or ghost images of previous scenes or objects

**Possible cause**

Manual calibration has been performed with the lens cover open.

**Solution**

Check the [Calibration Mode](#), close the lens cover and [calibrate](#) the device.

Black screen after calibration

**Solution**

If the image does not clear after calibration, you need to recalibrate.

Image is too dark

**Possible cause**

Brightness or contrast level is too low.

**Solution**

Adjust the brightness or contrast in the [Quick Menu](#).

Color bars appear on the display or the image disappears

**Possible cause**

The device was exposed to static charges during operation.

**Solution**

When the exposure to static charges is over, the device may either reboot automatically or require to be switched off and on again.

The image of the object being observed is missing

**Possible cause**

You are looking through glass.

**Solution**

Remove the glass or change the viewing position to avoid it.

Poor image quality / reduced detection distance

**Possible cause**

These problems may occur during observation in adverse weather conditions (snow, rain, fog, etc.).

Smartphone or tablet cannot be connected to the device.

**Possible cause**

The device password has been changed.

**Solution**

Delete the network and connect again using the password saved in the device.

**Possible cause**

The device is in an area with too many Wi-Fi networks that may be causing signal interference.

**Solution**

To ensure a stable Wi-Fi connection, relocate the device to an area with fewer or no Wi-Fi networks.

Smartphone or tablet cannot be connected to the device

**Possible cause**

The device password has been changed.

**Solution**

Delete the network and connect again using the password saved in the device.

**Possible cause**

The device is in an area with too many Wi-Fi networks that may be causing signal interference.

**Solution**

To ensure a stable Wi-Fi connection, relocate the device to an area with fewer or no Wi-Fi networks.

More information on solving problems with connection to Stream Vision by following the [link](#).

Missing or interrupted broadcasting via Wi-Fi

**Possible cause**

The smartphone or tablet is beyond reliable Wi-Fi range. There are obstacles between the device and the signal receiver (e.g. concrete walls).

**Solution**

Move the devices in line-of-sight and within range of the Wi-Fi signal.

More information on solving problems with connection to Stream Vision by following the [link](#).

When the device is used in low temperature conditions the image quality is worse than in positive temperatures.

**Possible cause**

In positive temperature conditions, objects being observed (surroundings and background) heat up differently because of thermal conductivity, thereby generating a high temperature contrast.

Consequently, the image quality produced by the thermal imager will be better.

In low-temperature conditions, objects being observed (background) will cool down to roughly the same temperature, which leads to a greatly reduced temperature contrast and a degraded image quality. This is normal for all thermal imaging devices.

[Remote control does not work](#)

**Possible cause**

The Bluetooth module is not turned on.

**Solution**

Turn on the Bluetooth module according to the instructions (see the [Bluetooth](#) section).

**Possible cause**

The Remote control is not activated.

**Solution**

Activate the remote control according to instructions (see the [Remote Control Activation](#) section).

**Possible cause**

The Remote Control is out of range of the device.

**Solution**

Return to the device coverage area.



**Possible cause**

Remote control battery low.

**Solution**

Install a new CR2032 battery as follows: unscrew the screws on the rear cover of the Remote Control, remove the cover, install a new battery, and screw the cover with screws.

## LEGAL COMPLIANCES AND DISCLAIMERS

**Attention!** A license is required for Thermal Imaging Front Attachment Proton FXQ30 when exporting outside your country.

**Electromagnetic compatibility.** This product complies with the requirements of European standard EN 55032: 2015, Class A.

**Caution!** Operation of this equipment in a residential environment could cause radio interference.

This product is subject to change in line with improvements to its design.

Repair of the device is possible within 5 years.

